

HLINÍKOVÝ ZÁVĚS

BH
105
40



Obj. č.	Popis	g
084.500.016	Šrouby M6x16 DIN 7984 nejsou součástí balení	100

Materiál: anodizovaný hliník; Čep Ø 8 mm - nerezová ocel AISI 303

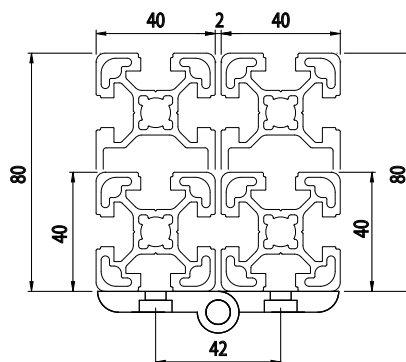
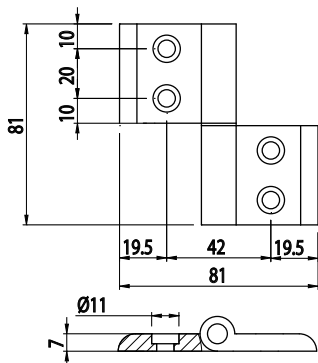

HLINÍKOVÝ ZÁVĚS

BH
105
45

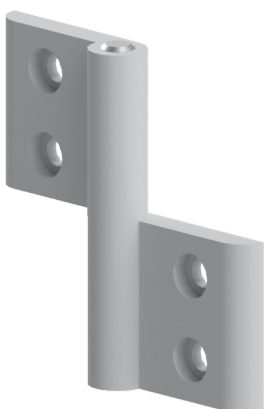

Obj. č.	Popis	g
084.500.003	Šrouby M6x16 DIN 7984 nejsou součástí balení	99

Materiál: anodizovaný hliník; Čep Ø 8 mm - nerezová ocel AISI 303

