

Mounting Accessories for Cylinders

Mounting for ISO 15552 in steel

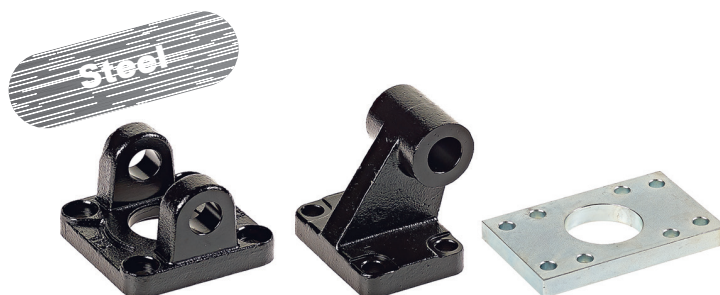

Standard executions		
Version	Sym.	Type
Rear clevis		CF..AQIS
Rear eye		CM..AQIS
Rear 90° hinge CETOP RP 107P		ASV..AQIS
Pin with rear clevis MP2 with seeger		SEC..AQIS
Narrow rear clevis		CFS..AQIS
Narrow rear eye with bearing DIN 648K		CMS..AQIS
Rear 90° hinge with bearing DIN 648K		ASS..AQIS
Anti-rotating pin for narrow rear clevis		SEC.. ARAQIS
Flange ISO 6431		FL..AQIS
Flange VDMA		FLV..AQIS
Low foot		PB..AQIS
Round adjustable centre trunnion (tie rod)		CT..AQIS
Centre trunnion (profile barrel)		CTS..AQIS
Round centre trunnion not adjustable (threaded)		CTN..AQIS
Support for centre trunnion (tie rod)		ST..AQIS
Front clevis		CFA..AQIS
Centre trunnion (tie rod) for heads		CTA..AQIS



Technical data					
Type	Materials and treatments				
	Steel A105	Steel AVP	Fe 37	Black cataphoresis	White zinking
CF..AQIS	•			•	
CM..AQIS	•			•	
ASV..AQIS	•			•	
SEC..AQIS		•			
CFS..AQIS	•			•	
CMS..AQIS	•			•	
ASS..AQIS	•			•	
SEC..ARAQIS		•			
FL..AQIS			•		•
FLV..AQIS			•		•
PB..AQIS			•		•
CT..AQIS	•				•
CTS..AQIS	•				•
CTN..AQIS	•				•
ST..AQIS			•		•
CFA..AQIS	•			•	
CTA..AQIS	•				•

Note: The mounting screws are to be ordered separately.
For screws see page 1.101.1.

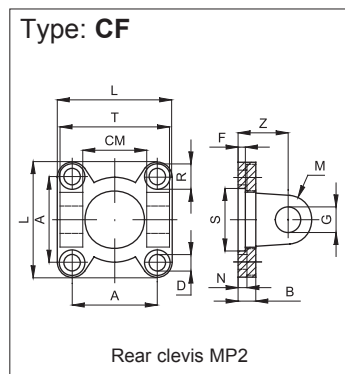

Code	Item	For cyl. Ø mm	A	L	D	R	N	B	S	F	Z	G	M	CM	T	Weight (g)
040461	CF32AQIS	32	32,5	45	6,6	11	5,5	10	30	5	22	10	10	26	45	138
040462	CF40AQIS	40	38	55	6,6	11	5,5	10	35	5	25	12	12	28	52	230
040463	CF50AQIS	50	46,5	65	9	15	6,5	10	40	5	27	12	12	32	60	338
040464	CF63AQIS	63	56,5	75	9	15	6,5	12	45	5	32	16	16	40	70	540
040465	CF80AQIS	80	72	95	11	18	10	14	45	-	36	16	16	50	90	1000
040466	CF100AQIS	100	89	115	11	18	10	16	55	-	41	20	20	60	110	1700
040467	CF125AQIS	125	110	140	13,5	20	10	20	60	-	50	25	25	70	130	3350
040468	CF160AQIS	160	140	180	18	26	10	20	65	7	55	30	25	90	170	5750
040469	CF200AQIS	200	175	220	18	26	11	20	75	7	60	30	25	90	170	8900

The pin has to be ordered separately: for the pin see page 1.98.2 (SEC..AQIS)

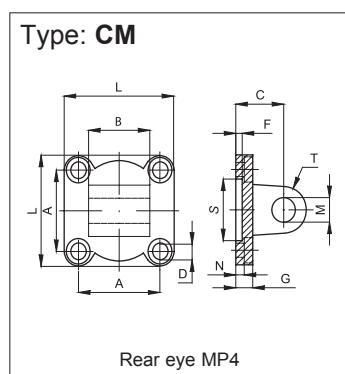

Code	Item	For cyl. Ø mm	A	L	D	R	N	G	S	F	C	M	T	B	Weight (g)	
040521	CM32AQIS	32	32,5	45	6,6	11	5,5	10	30	5	22	10	10	26	176	
040522	CM40AQIS	40	38	55	6,6	11	5,5	10	35	5	25	12	12	28	274	
040523	CM50AQIS	50	46,5	65	9	15	6,5	10	40	5	27	12	12	32	-0,2	368
040524	CM63AQIS	63	56,5	75	9	15	6,5	12	45	5	32	16	16	40	-0,6	682
040525	CM80AQIS	80	72	95	11	18	10	14	45	5	36	16	16	50	1196	
040526	CM100AQIS	100	89	115	11	18	10	16	55	5	41	20	20	60	2100	
040527	CM125AQIS	125	110	140	13,5	20	10	20	60	7	50	25	25	70	3740	
040528	CM160AQIS	160	140	180	18	26	10	20	65	7	55	30	25	90	-0,5	5890
040529	CM200AQIS	200	175	220	18	26	11	20	75	7	60	30	25	90	-1,2	8470



Mounting Accessories for Cylinders

Mounting for ISO 1552 in steel



Type: ASV

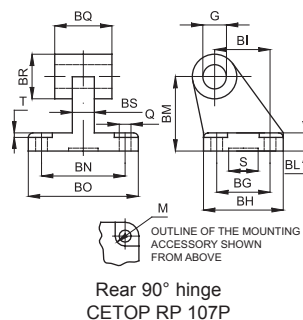

Code	Item	For cyl. Ø mm	Q	M	BG	BH	BI	BL	BM	BN	BO	BS	BR	BQ	G	T	S	Weight (g)
040381	ASV32AQIS	32	6,6	11	18	31	21	8	32	38	51	10	20	26	10	1,6	20	158
040382	ASV40AQIS	40	6,6	11	22	35	24	10	36	41	54	10	22	28	12	1,6	20	238
040383	ASV50AQS	50	9	15	30	45	33	12	45	50	65	14	26	32	12	1,6	20	418
040384	ASV63AQIS	63	9	15	35	50	37	14	50	52	67	14	30	40	16	1,6	20	526
040385	ASV80AQIS	80	11	18	40	60	47	14	63	66	86	18	30	50	16	2,5	20	1055
040386	ASV100AQIS	100	11	18	50	70	55	17	71	76	96	20	38	60	20	2,5	20	1360
040387	ASV125AQIS	125	14	20	60	90	70	20	90	94	124	30	45	70	25	3,2	-	-

Type: SEC

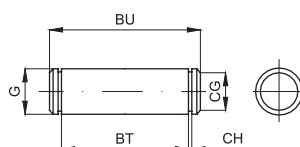

Pin for rear clevis MP2

Code	Item	For cyl. Ø mm	G	BT	CG	CH	BU	Weight (g)
040261	SEC32AQIS	32	10	46	9,6	1,1	53	32
040262	SEC40AQIS	40	12	53	11,5	1,1	60	52
040263	SEC50AQIS	50	12	61	11,5	1,1	68	60
040264	SEC63AQIS	63	16	71	15,2	1,1	78	122
040265	SEC80AQIS	80	16	91	15,2	1,1	98	152
040266	SEC100AQIS	100	20	111	19	1,3	118	290
040267	SEC125AQIS	125	25	132	23,9	1,3	139	530
040268	SEC160AQIS	160	30	171,5	28,6	1,6	178	978
040269	SEC200AQIS	200	30	171,5	28,6	1,6	178	978
040270	SEC250AQIS	250	40	202	37,5	1,6	211	2100

It is supplied with 2 seegers included.

Type: CFS

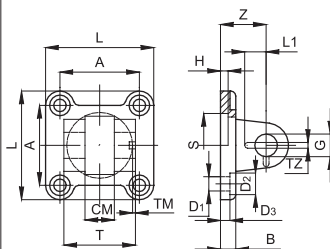

Narrow rear clevis for rear male trunnion with bearing DIN 648 K

Code	Item	For cyl. Ø mm	L	T	CM	A	Z	H	B	D ₃	S	G	D ₁	D ₂	TA	TZ	LI	Weight (g)
040491	CFS32AQIS	32	45	34	14	32,5	22	5	10	5,5	30	10	6,6	11	3	3,3	11,5	140
040492	CFS40AQIS	40	55	40	16	38	25	5	10	5,5	35	12	6,6	11	4	4,3	12	230
040493	CFS50AQIS	50	65	45	21	46,5	27	5	10	6,5	40	16	9	15	4	4,3	14	336
040494	CFS63AQIS	63	75	51	21	56,5	32	5	12	6,5	45	16	9	15	4	4,3	14	546
040495	CFS80AQIS	80	95	65	25	72	36	5	16	10	45	20	11	18	4	4,3	16	1190
040496	CFS100AQIS	100	115	75	25	89	41	5	16	10	55	20	11	18	4	6,3	16	1840
040497	CFS125AQIS	125	140	97	37	110	50	7	20	10	60	30	13,5	20	6	6,3	24	3550

The pin is has be ordered separately: for pins see page 1.98.3 (SEC..ARAQIS).

Type: CMS

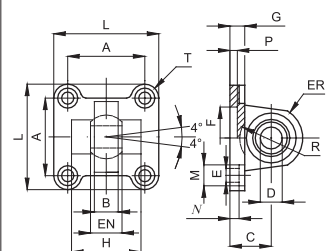

Narrow rear eye for rear male trunnion with bearing DIN 648 K

Code	Item	For cyl. Ø mm	A	B	C	D	EN	ER	F	G	E	L	M	N	P	H	R	Weight (g)
040531	CMS32AQIS	32	32,5	10,5	22	10	14	15	30	10	6,6	45	10,5	5,5	5	-	-	152
040532	CMS40AQIS	40	38	12	25	12	16	18	35	10	6,6	55	11	5,5	5	-	-	256
040533	CMS50AQIS	50	46,5	15	27	16	21	20	40	10	9	65	15	6,5	5	51	19	364
040534	CMS63AQIS	63	56,5	15	32	16	21	23	45	12	9	75	15	6,5	5	-	-	595
040535	CMS80AQIS	80	72	18	36	20	25	27	45	14	11	95	18	10	5	-	-	1122
040536	CMS100AQIS	100	89	18	41	20	25	30	55	16	11	115	18	10	5	-	-	1786
040537	CMS125AQIS	125	110	26	50	30	37	40	60	20	13,5	140	20	10	7	-	-	3500

Mounting Accessories for Cylinders

Mounting for ISO 1552 in steel



Type: ASS

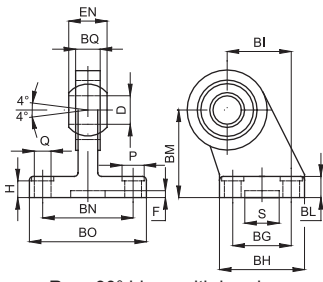

Rear 90° hinge with bearing
DIN 648 K

Code	Item	For cyl. Ø mm	Q	M	BG	BH	BI	BL	BM	BN	BO	EN	ER	BQ	D	H	S	F	Weight (g)
040551	ASS32AQIS	32	6,6	11	18	31	21	10	32	38	51	14	15	10,5	10	8,5	20	3	178
040552	ASS40AQIS	40	6,6	11	22	35	24	10	36	41	54	16	18	12	12	8,5	20	3	268
040553	ASS50AQS	50	9	15	30	45	33	12	45	50	65	21	20	15	16	10,5	20	3	458
040554	ASS63AQIS	63	9	15	35	50	37	12	50	52	67	21	23	15	16	10,5	20	3	550
040555	ASS80AQIS	80	11	18	40	60	47	14	63	66	86	25	27	18	20	11,5	20	3	970
040556	ASS100AQIS	100	11	18	50	70	55	15	71	76	96	25	30	18	20	12,5	20	3	1326
040557	ASS125AQIS	125	13,5	20	60	90	70	20	90	94	124	37	40	25	30	17	20	3	3000

Type: SEC - AR

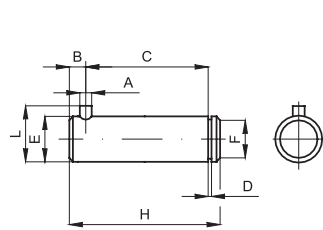

Anti-rotating pin for narrow
rear clevis

Code	Item	For cyl. Ø mm	A	C	D	E	F	G	H	L	B	Weight (g)	
040571	SEC32ARAQIS	32	3	32,5	1,1	10	9,6	4	41	14	4,5	0 -1	26
040572	SEC40ARAQIS	40	4	38	1,1	12	11,5	4	48	16	6		42
040573	SEC50ARAQIS	50	4	43	1,1	16	15,2	5	54	20	6		84
040574	SEC63ARAQIS	63	4	49	1,1	16	15,2	5	60	20	6		94
040575	SEC80ARAQIS	80	4	63	1,3	20	19	6	75	24	6	184	
040576	SEC100ARAQIS	100	4	73	1,3	20	19	6	85	24	6	208	
040577	SEC125ARAQIS	125	6	94	1,6	30	28,6	7	110	36	9	0	606
040578	SEC160ARAQIS	160	6	119	1,6	35	33	7	135	41	9	-2	972
040579	SEC200ARAQIS	200	6	119	1,6	35	33	7	135	41	9		972

It is supplied with 1 seeger included.

Type: FL

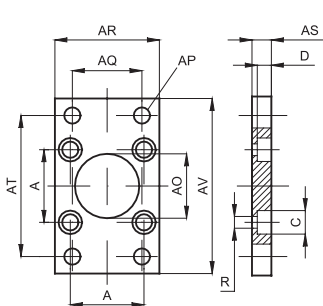

Flange ISO MF1 / MF2

Code	Item	For cyl. Ø mm	A	AP Ø	AO	R	AS	AR	AQ	AT	AV	C	D	Weight (g)
040661	FL32AQIS	32	32,5	7	30	6,5	10	45	32	64	80	10,5	6,5	190
040662	FL40AQIS	40	38	9	35	6,5	10	52	36	72	90	10,5	6,5	246
040663	FL50AQIS	50	46,5	9	40	8,5	12	65	45	90	110	13,5	8,5	478
040664	FL63AQIS	63	56,5	9	45	8,5	12	75	50	100	120	13,5	8,5	622
040665	FL80AQIS	80	72	12	45	10,5	16	95	63	126	150	16,5	10,5	1430
040666	FL100AQIS	100	89	14	55	10,5	16	115	75	150	170	16,5	10,5	1986
040667	FL125AQIS	125	110	16	60	13,5	20	140	90	180	205	20	12,5	3750
040668	FL160AQIS	160	140	18	65	17	20	180	115	230	260	25	16,5	6350
040669	FL200AQIS	200	175	22	75	17	25	220	135	270	300	25	16,5	11350
040670	FL250AQIS	250	220	26	90	22,5	25	285	165	330	400	33	20	20100

Type: FLV

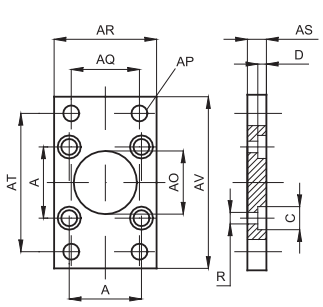

Flange VDMA MF1 / MF2

Code	Item	For cyl. Ø mm	A	AP Ø	AO	R	AS	AR	AQ	AT	AV	C	D	Weight (g)
040671	FLV32AQIS	32	32,5	7	30	6,6	10	45	32	64	80	10,5	5	192
040672	FLV40AQIS	40	38	9	35	6,6	10	52	36	72	90	11	5	250
040673	FLV50AQIS	50	46,5	9	40	9	12	65	45	90	110	15	5,5	480
040674	FLV63AQIS	63	56,5	9	45	9	12	75	50	100	120	15	5,5	620
040675	FLV80AQIS	80	72	12	45	11	16	95	63	126	150	18	8	1415
040676	FLV100AQIS	100	89	14	55	11	16	115	75	150	170	18	8	1985
040677	FLV125AQIS	125	110	16	60	13,5	20	140	90	180	205	20	9,5	3750
040678	FLV160AQIS	160	140	18	65	18	20	180	115	230	260	26	10,5	6350
040679	FLV200AQIS	200	175	22	75	18	25	220	135	270	300	26	12,5	11300
040680	FLV250AQIS	250	220	26	90	22	25	285	165	330	400	33	14,5	20150
040656	FLV320AQIS	320	270	33	110	26	30	350	200	400	470	39	15	34550

Lowered head screws type VBTR (see page 1.101.1) must be used with this mounting accessory.



Mounting Accessories for Cylinders

Mounting for ISO 1552 in steel



Type: PB

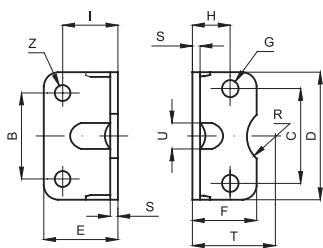

Low foot MS1

It is supplied singly.

Code	Item	For cyl. Ø mm	C	B	D	E	F	G	H	I	S	T	R	U	Z	Weight (g)
040201	PB32AQIS	32	32,5	32	45	35	30	7	15,75	24	4	32	15	11	7	66
040202	PB40AQIS	40	38	36	52	36	30	7	17	28	4	36	17,5	15	9	78
040203	PB50AQIS	50	46,5	45	65	47	36	9	21,75	32	5	45	20	16	9	168
040204	PB63AQIS	63	56,5	50	75	45	35	9	21,75	32	5	50	22,5	18	9	190
040205	PB80AQIS	80	72	63	95	55	47	11	27	41	6	63	22,5	17	12	382
040206	PB100AQIS	100	89	75	115	57	53	11	26,5	41	6	71	27,5	24	14	452
040207	PB125AQIS	125	110	90	140	70	70	14	35	45	8	90	30	-	16	1090
040208	PB160AQIS	160	140	115	180	75	100	18	45	60	9	115	32,5	-	18	1188
040209	PB200AQIS	200	175	135	220	100	100	18	47,5	70	12	135	37,5	-	22	3450

Type: CT

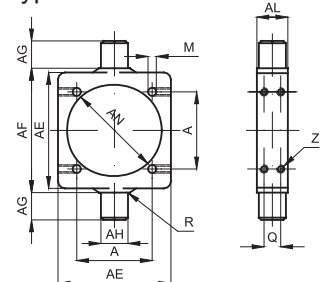

Round adjustable centre trunnion (tie rod) MT4

Code	Item	For cyl. Ø mm	A	AE	AL	AH e9	AG h14	AF h14	AN	R	M	Q	Z	Weight (g)
040581	CT32AQIS	32	32,5	46	15	12	12	50	37	1	6,25	7	M5	110
040582	CT40AQIS	40	38	59	20	16	16	63	46	1,5	6,25	8	M5	290
040583	CT50AQIS	50	46,5	69	20	16	16	75	56	1,6	8,25	8	M6	330
040584	CT63AQIS	63	56,5	84	25	20	20	90	69	1,6	8,25	12	M6	650
040585	CT80AQIS	80	72	102	25	20	20	110	87	1,6	10,25	12	M8	830
040586	CT100AQIS	100	89	125	30	25	25	132	107	2	10,25	15	M8	1560
040587	CT125AQIS	125	110	155	32	25	25	160	133	2	12,25	15	M10	2450
040588	CT160AQIS	160	140	190	40	32	32	200	170	2,5	16,25	18	M12	4150
040589	CT200AQIS	200	175	240	40	32	32	250	211	2,5	16,25	18	M12	7300

Type: CTS

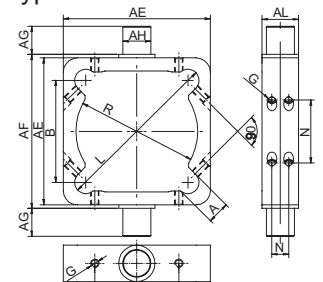

Centre trunnion (profile barrel) MT4 for cylinders AMA

Code	Item	For cyl. Ø mm	B	AE	AL	AH e9	AG h14	AF h14	R	L	G	A	M	N	O	Weight (g)
040601	CTS32AQIS	32	33	48,5	18	12	12	50	37	57	M5	11	15,5	7	/	104
040602	CTS40AQIS	40	38	59	20	16	16	63	46	64	M6	11	20	8	/	234
040603	CTS50AQIS	50	48	71	20	16	16	75	56	82	M6	14	22,5	8	/	300
040604	CTS63AQIS	63	58	84	26	20	20	90	69	96	M6	14	30	12	/	577
040605	CTS80AQIS	80	73	105	26	20	20	110	87	119	M6	16	45	12	58	858
040606	CTS100AQIS	100	91	129	32	25	25	132	107	144,5	M8	17	60	15	74	1565
040607	CTS125AQIS	125	116	154	33	25	25	160	133	181	M8	18	85,5	15	104	1932

Type: CTN

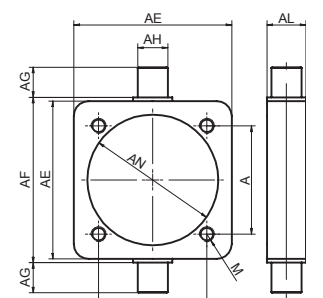

Round centre trunnion not adjustable (threaded) MT4

Code	Item	For cyl. Ø mm	A	AE	AL	AH e9	AG h14	AF h14	AN	M	Weight (g)
040052	CTN32AQIS	32	32,5	46	15	12	12	50	37	M6	110
040053	CTN40AQIS	40	38	59	20	16	16	63	46	M6	290
048590	CTN50AQIS	50	46,5	69	20	16	16	75	56	M8	330
040564	CTN63AQIS	63	56,5	84	25	20	20	90	69	M8	650
040096	CTN80AQIS	80	72	102	25	20	20	110	87	M10	830
040097	CTN100AQIS	100	89	125	30	25	25	132	107	M10	1560
040098	CTN125AQIS	125	110	155	32	25	25	160	133	M12	2450
040099	CTN160AQIS	160	140	190	40	32	32	200	170	M16	4150
040100	CTN200AQIS	200	175	240	40	32	32	250	211	M16	7300
040110	CTN250AQIS	250	220	296	50	40	40	320	268	M20	13050
040590	CTN320AQIS	320	270	370	60	50	50	400	343	M24	-

Mounting Accessories for Cylinders

Mounting for ISO 15552 in steel



Type: ST

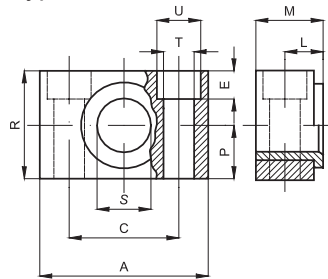

Support for centre trunnion (tie rod)

It is supplied singly.

Code	Item	For cyl. Ø mm	A	M	R	P	C	S	L	U	T	E	Weight (g)
040681	ST32AQIS	32	46	18	30	15	32	12	10,5	11	6,6	7	100
040682	ST40-50AQIS	40-50	55	21	36	18	36	16	12	15	9	9	150
040684	ST63-80AQIS	63-80	65	23	40	20	42	20	13	18	11	11	234
040686	ST100-125AQIS	100-125	75	28,5	50	25	50	25	16	20	14	13	435
040688	ST160-200AQIS	160-200	92	40	60	30	60	32	22,5	26	18	17	850

Type: CFA

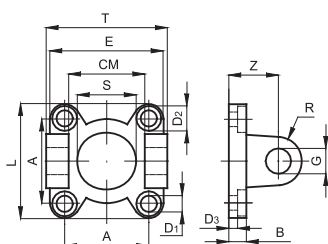

Front clevis MP7

Code	Item	For cyl. Ø mm	A	E	D ₁	D ₂	D ₃	B	S	Z	G	R	CM	T	Weight (g)
040611	CFA32AQIS	32	32,5	45	6,5	10,5	8	10	30	22	10	10	32	50	125
040612	CFA40AQIS	40	38	55	6,5	10,5	8	10	35	25	12	12	37	58	214
040613	CFA50AQIS	50	46,5	65	8,5	13,5	8	10	40	27	12	12	42	70	298
040614	CFA63AQIS	63	56,5	75	8,5	13,5	10	12	45	32	16	16	47	75	518

Type: CTA

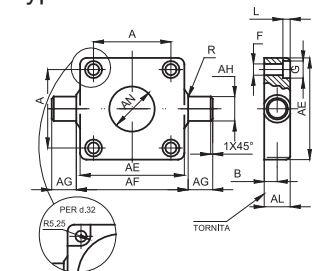

Centre trunnion (tie rod) for heads

Code	Item	For cyl. Ø mm	AE	AL	AH	AG	AF	AN	A	B	F	G	L	R	Weight (g)
040591	CTA32AQIS	32	46	14	12	12	50	30	32,5	6,5	6,5	-	6	1	137
040592	CTA40AQIS	40	59	19	16	16	63	35	38	9	6,5	10,5	6	1,6	385
040593	CTA50AQIS	50	69	19	16	16	75	40	46,5	9	8,5	13,5	8	1,6	513
040594	CTA63AQIS	63	84	24	20	20	90	45	56,5	11,5	8,5	13,5	8	1,6	1041
040595	CTA80AQIS	80	102	24	20	20	110	45	72	11,5	10,5	16,5	10	1,6	1567
040596	CTA100AQIS	100	125	29	25	25	132	55	89	14	10,5	16,5	10	2	3000